

TE-Cooling USB3.0 InGaAs Short-Wave Infrared (SWIR) Camera

STSWIR Series



2022 V1

For customized projects please Contact us:

sales@simtrum.cn

SIMTRUM STSWIR Series STSWIR1300KMA Camera is a TE-Cooling USB3.0 InGaAs SWIR camera, which adopts Sony IMX990 ½ - Type Short-Wave Infrared (SWIR) Image Sensor. It is suitable to capture images in both visible range and SWIR range, covering 400 nm to 1700nm. With a smaller pixel size of 5um, imaging shows higher precision for quantitative research.

We offer the STSWIR330KMA Camera, which adopts Sony IMX991 ¼” – Type Short-Wavelength Infrared (SWIR) Image Sensor. It is the other good choice for you.



Features

- InGaAs SWIR USB3.0 camera
- Built-in Thermoelectric cooler
- High resolution up to 1.3MP
- Visible and SWIR imaging 400nm-1700nm
- High sensitivity low noise
- High quantum efficiency

Application

- Electronic board inspection
- Solar cell inspection
- Semiconduction inspection
- Transmission observation
- Produce inspection, identifying, and sorting
- Water visualization
- Temperature observation
- Surveillance
- Anti-counterfeiting.

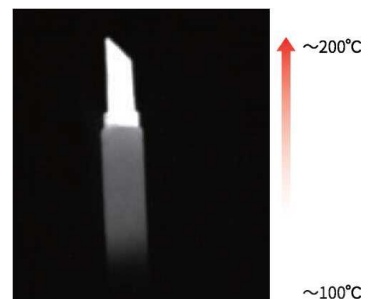

Short-wave infrared high-end night vision security applications are also the best choice.

Specifications

Model Number	Image Sensor	Pixel Size(μm)	G Sensitivity Dark Signal	FPS/Resolution	Binning	Exposure Time
STSWIR1300KMA	1.3M/IMX990(M) 1/2"(6.40x5.12)	5 x5	121mV with 1/30s 1.0mV with 1/30s	132@1280x1024 253@640x512	1x1 1x1	50us~3600s
STSWIR330KMA	0.33M/IMX991(M) 1/4"(3.20x2.56)	5 x5	121mV with 1/30s 1.0mV with 1/30s	258.8@640x512 486.1@320x256	1x1 1x1	50us~60s

C: Color; M: Monochrome;

Parameters	STSWIR1300KMA 1.31M pixels 1/2" CMOS USB3.0 Industrial Camera	STSWIR330KMA 0.33M pixels 1/4" CMOS USB3.0 Industrial Camera
Sensor Model	Sony IMX990-AABA-C	Sony IMX991-AABA-C
Sensor Type	InGaAs	
Spectral Range	400nm-1700nm	
Pixel Size	5.0 um x 5.0 um	
Sensor Size	1/2"	1/4"
ADC	12 Bit/8 Bit	
Frame Rate	8 Bit: 132fps@1280x1024 / 253fps@640x512 12 Bit: 70fps@1280x1024 / 135fps@640x512	8 Bit: 258.8fps@640x512 / 486.1fps@320x256 12 Bit: 137.7fps@640x512 / 258.0fps@320x256
Image Buffer	512MByte	
Conversion Gain	44.3e/ADU	
Dynamic Range	58.7dB	
Readout Noise	211e	
Full Well	181.6ke	
SNRmax	52.6dB	
Sensitivity	121mV	
Dark Current	383e/s(0°C) 510e/s(10°C) 638e/s(20°C)	
Gain Range	1x-15x	
Exposure Time	50us-3600sec	50us-60sec
Shutter	Global shutter	
Binning	Software2x2,3x3,4x4	
Data Interface	USB3.0	
Data Format	Mono8/Mono12	
Digital I/O	One optical-coupling isolated input, one optical-coupling isolated output, tow non-isolated input and output	
Cooling Performance	25-30°C below ambient temperature	
Optical Filter	-	400-1800nm(default) / 1030-1800nm (optional)
CRA	-	2.35 Deg

General Specification

Power Supply	Power with USB3.0 and 12V Power adapter	
Power Consumption	<2.1W(no cooling) / <25W(cooling)	
Temperature	Working temperature -20~60°C, storage temperature -40~85°C	
Flumidity	20%-80%, no condensation	
Size	80mm x 80mm x 62.9mm	80mm x 80mm x 45.5mm
Weight	648g	380g
Lens Mount	C-mount	
Software	SDK	
Operating System	Win32/WinRT/Linux/macOS/Android	
Certification	CE, FCC	

Spectral Response

STSWIR1300KMA

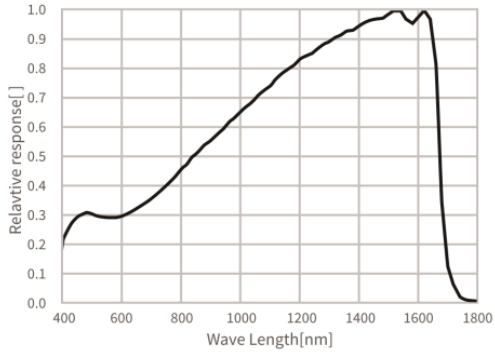

STSWIR1300KMA Spectral Response

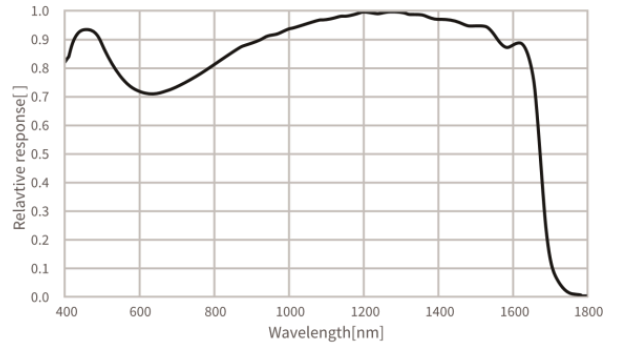

STSWIR1300KMA Quantum Efficiency

STSWIR330KMA

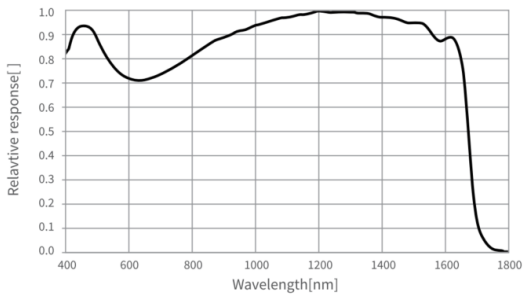

STSWIR330KMA Relative Quantum Efficiency

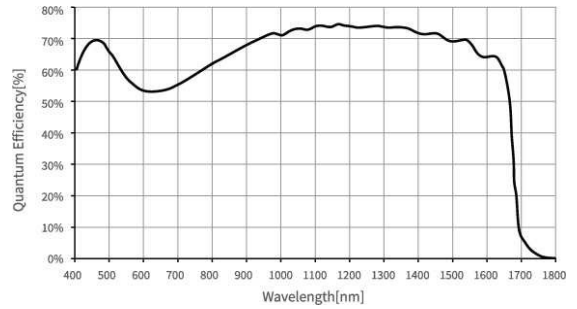

STSWIR330KMA Absolute Quantum Efficiency

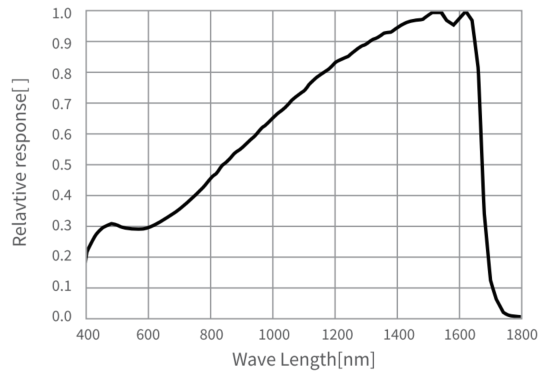

STSWIR330KMA Spectral Response

Dimension

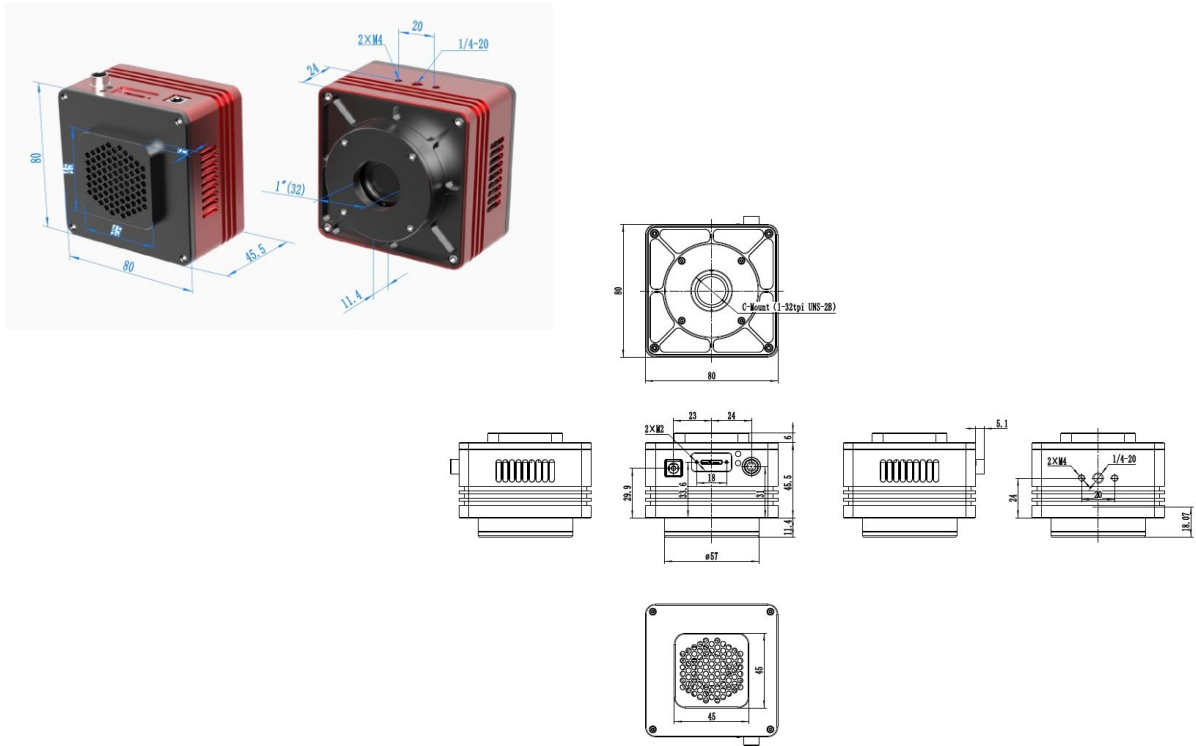

Packing Information



Standard Package	
B	3-A safety equipment case: L:28cm W:23cm H:15.5cm (1pcs, 2.8Kg/ box); Carton size: L:28.2cm W:25.2cm H:16.7cm(TBD)
C	One STSWIR series camera(C-mount)
D	D1, D2, D3 and D4 are national standard, American Standard, European standard, and British standard power lines respectively
E	Power adapter: input: AC 100~240V 50Hz/60Hz, output: DC12 V 3A
F	High-Speed USB3.0 A male to B male gold-plated connectors cable /1.5m
H	One external trigger control cable
G	CD (Driver & utilities software, Ø12cm)